

CURRENT TRANSFORMERS

AST1256 - Protective current transformers

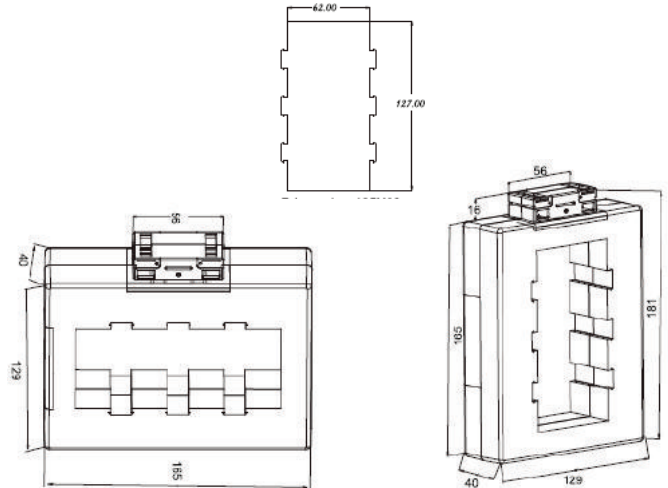

Dimensions:	
AST1256	165 x 145 x 40 mm
AST1256V	129 x 181 x 40 mm
Primary bar:	125 x 60 mm



AST1256/AST1256V Technical Features, Executions

Primary rated current A	Rated burdens VA (sec. .../5A)			
	Class 5P10	Class 10P10	Class 5P20	Class 10P20
1500	10	10	2.5	2.5
2000	15	15	5	5
2500	20	20	5	5
3000	20	20	5	5
3200	30	30	7.5	7.5
3500	30	30	7.5	7.5
4000	20	20	-	-

Included: Primary busbar

Accessories: mounting feet / Snap on mounting EN 50022-35

AST1656 - Protective current transformers

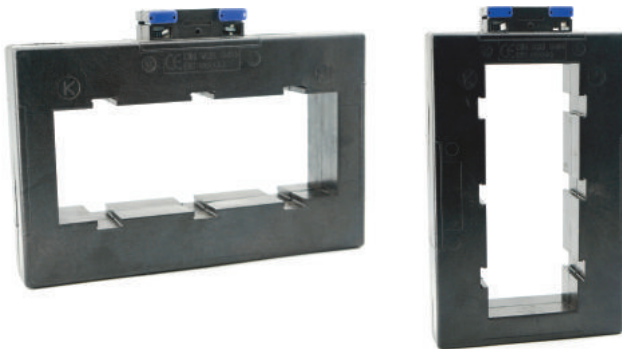

Dimensions:	
AST1656	205 x 145 x 40 mm
AST1656V	129 x 221 x 40 mm
Primary bar:	165 x 60 mm

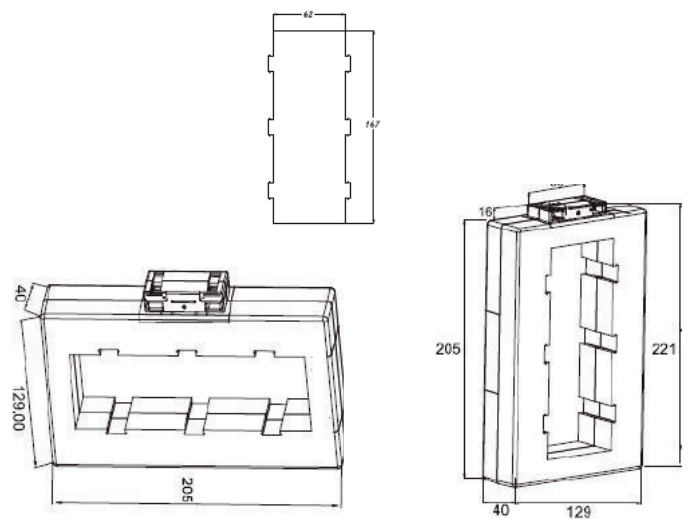

AST1656/AST1656V Technical Features, Executions

Primary rated current A	Rated burdens VA (sec. .../5A)			
	Class 5P10	Class 10P10	Class 5P20	Class 10P20
2000	15	15	2.5	2.5
2500	20	20	3.75	3.75
3000	20	20	5	5
3200	20	20	5	5
3500	20	20	5	5
4000	30	30	5	5
5000	30	30	7.5	7.5

Included: Primary busbar

Accessories: mounting feet / Snap on mounting EN 50022-35